

Jan. 20. 1925.

1,523,686

J. G. DAVIES
GAME APPARATUS

Filed June 20, 1923

2 Sheets-Sheet 1

Fig. 1

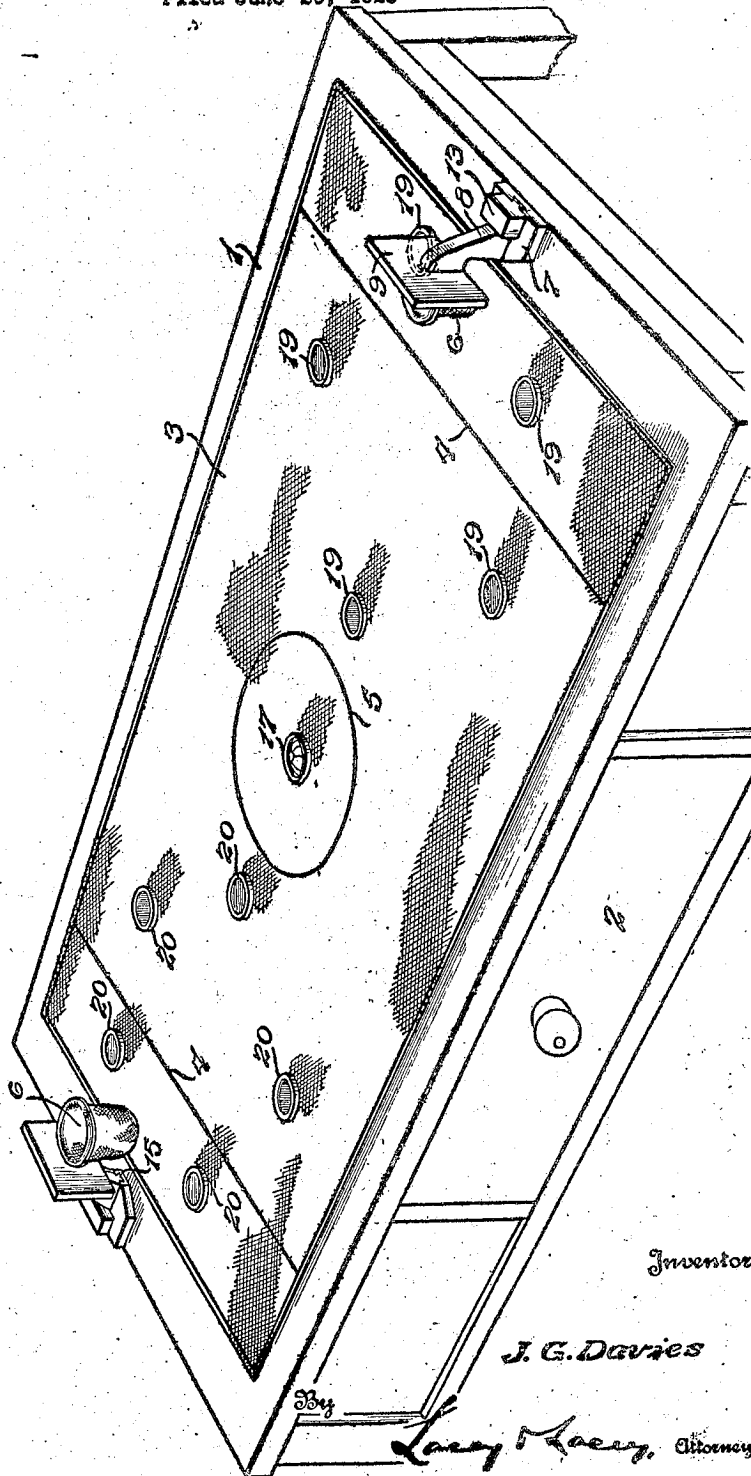

Inventor

J. G. Davies

384

Larry Macy, Attorneys

Jan. 20, 1925.

1,523,686

J. G. DAVIES

GAME APPARATUS

Filed June 20, 1923

2 Sheets-Sheet 2

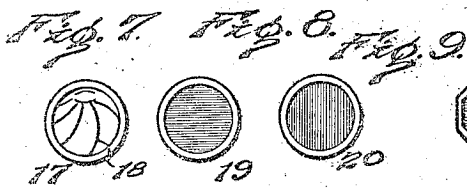
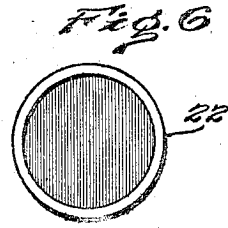
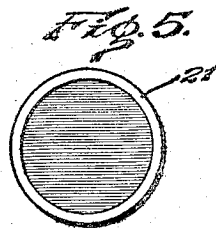
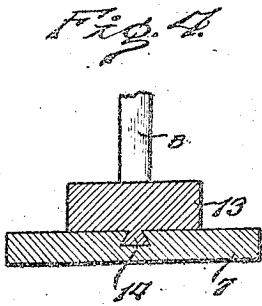
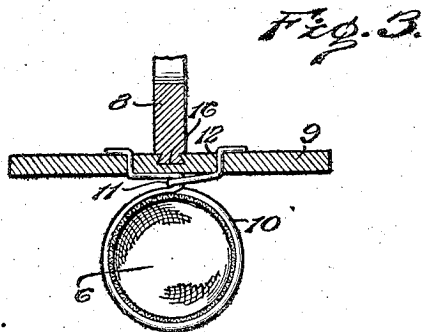
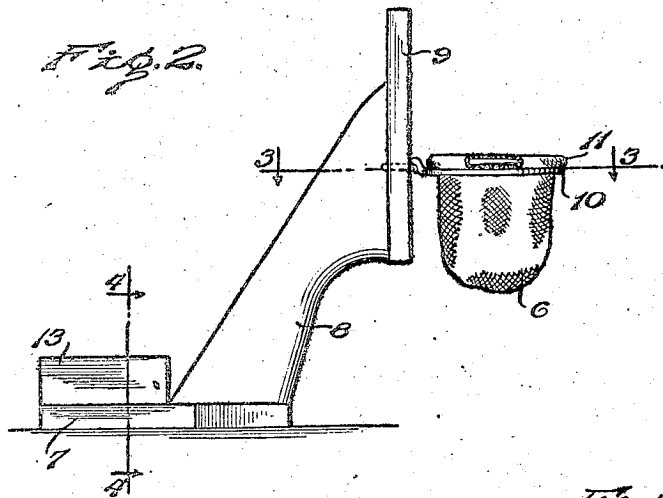

Fig. 10. Inventor

J. G. Davies

By

Lamy, Lamy, Attorney

UNITED STATES PATENT OFFICE.

JAMES G. DAVIES, OF LOGAN, UTAH.

GAME APPARATUS.

Application filed June 20, 1923. Serial No. 646,601.

To all whom it may concern:

Be it known that I, JAMES G. DAVIES, a citizen of the United States, residing at Logan, in the county of Cache and State of Utah, have invented certain new and useful Improvements in Game Apparatus, of which the following is a specification.

This invention relates to indoor amusement apparatus and seeks to provide a toy simulating apparatus employed in the game of basket ball and operable to permit the playing of a game resembling basket ball. Apparatus embodying my invention is illustrated in the accompanying drawings, and the invention resides in certain novel features which will be particularly pointed out in claims following a detailed description.

In the annexed drawings:

Figure 1 is a perspective view of apparatus embodying my invention;

Fig. 2 is an enlarged side elevation of one of the goals;

Fig. 3 is a horizontal section on the line 3—3 of Fig. 2;

Fig. 4 is a detail vertical section on the line 4—4 of Fig. 2;

Figs. 5 and 6 are plan views of elements employed in the game according to my invention;

Figs. 7, 8 and 9 are plan views of other elements employed, and

Fig. 10 is a plan view showing an element corresponding to those shown in Figs. 8 and 9 but of a slightly different form.

In carrying out my invention, I may employ a table or other support 1 having a flat top and equipped with a drawer 2 in which the other elements of the apparatus may be stored when they are not in use. It is not necessary, however, to provide a special table inasmuch as the playing elements may be placed upon any table or other convenient support. The apparatus employed in playing a game according to my invention comprises a field 3 which may be of billiard cloth or similar material and is rectangular in outline and adapted to be placed flat and smooth upon the table 1. Across this field adjacent each end thereof is marked a line 4 which, in the parlance of the game, is denominated the free pitch line and at the center of the field is defined a circle 5. Upon the support at each end

of the field is provided a goal comprising a support and a basket 6 carried thereby, the goal being so disposed that the basket will be directly over the end of the playing field. The support constituting a part of the goal comprises a base 7, a standard 8 rising from the base and a back or bumper board 9 carried by the upper end of the standard, the basket 6 being mounted on the bumper by being inserted through a ring 10 fixed to the bumper with the marginal flange or bead 11 of the basket resting upon the said ring so that the basket will not drop there-through. The basket will be formed of any textile or other suitable material whereby the body of the basket may be easily inserted downwardly through the supporting ring and the ring may conveniently be formed of wire having its end portions twisted together, as shown at 11, and then separated and clinched through the bumper, as shown at 12. In order that the goal may be very easily and accurately placed in the proper position, the standard 8 is arranged obliquely, as shown most clearly in Fig. 2, and its upper end overhangs and projects beyond the base 7 whereby the bumper may be easily brought into the true vertical plane of the edge of the playing field. In order that the weight of the upper portion of the standard and the parts carried thereby may not overbalance and tilt the base 7, a counterweight 13 is provided, the said counterweight being placed upon the base at the outer end thereof, as shown clearly in Fig. 2, and thereby holding the base firmly against any tendency to tilt under the weight of the standard and the parts mounted thereon. In order that the goal may be easily assembled for use or may be disassembled so as to be stored conveniently in a very small space when not in use, the base is provided with a central longitudinal dovetailed slot or groove and the weight 13 is provided on its under side with a longitudinal central dovetailed rib 14 adapted to slidably engage said groove, as will be readily understood upon reference to Figs. 1 and 4. The lower end of the standard 8 is provided with a like dovetailed rib or tongue 15 also slidably engaged in the said groove, as shown at the left in Fig. 1, and upon the

front side of the standard at the upper end thereof is formed a similar dovetailed tongue or rib 16 slidably engaging a corresponding groove formed in the rear side of the bumper 9 at the lower portion thereof. When assembling the parts, it is necessary only to engage the tongues or ribs in the proper grooves and then merely place the assembled goal upon the supporting structure so that the bumper will be in the vertical plane of the adjacent end of the playing field. The game apparatus also includes a disk 17 of bone, celluloid, ivory, or some similar material, preferably circular in outline, and having flat faces so that it may rest flat upon the surface of the playing field. This disk 17 has lines 18 marked upon its upper face so that it has more or less resemblance to a ball and in playing the game will be identified as the ball. This ball, at the start of the game, is placed at the center of the circle 5 and the object of the game is to drive the ball into the goal guarded by the opponent. The game apparatus also includes pieces known as men and shown at 19 and 20, these pieces being similar in form and material to the ball but being given contrasting colors so as to be readily distinguished and to represent opposing sides in the game. There are also included in the apparatus two pieces, shown at 21 and 22, which may be called "flippers," these pieces corresponding in form and material to the pieces 19 and 20, respectively, and being likewise colored but being much larger than the said pieces 19 and 20. While the several men and flippers are preferably circular in outline, they may be given other forms, such as the octagonal outline shown at 23 in Fig. 10.

In playing the game, the ball is placed at the center of the playing field, as heretofore stated, and the several men are placed in positions upon the field at opposite sides of the center corresponding to the positions occupied by the forwards and guards in the game of basket ball. The players determine the choice of position upon the field by chance, as by tossing a coin, and the player losing the toss has the privilege of starting the game. The starting player places the edge of his flipper upon the edge of any one of his men and by exerting a squeezing pressure upon the man causes the same to jump toward the ball, the object being to cover or touch the ball with the man. If the player succeeds in this object, he is entitled to try to cause the ball to enter his opponent's goal. The ball is actuated in exactly the same manner as the man was previously moved and, if it is caused to jump into the basket, two points are scored by the successful player. If a player causes the ball to touch an opponent's man or causes his own man to touch

an opponent's man, the opponent has the privilege of playing the ball, and said opponent, in turn, tries to jump the ball into the goal guarded by the first player. If, in the course of the play, a man is forced off the playing field, it must be returned to the position initially occupied by it. If the ball is forced off the playing field, the player opposed to the player sending the ball off the field has the privilege of flipping it onto the field and if he succeeds in causing it to touch one of his men, he has another chance to drive it to the desired goal but he cannot flip it to the goal from outside the field. Various rules may be made to govern the game as the players may agree or circumstances suggest, the object always being to follow the game of basket ball as closely as possible. My apparatus is obviously simple and may be produced at a low cost. It may be easily set up for use and may be placed in a small compass out of the way when not in use. It will provide amusement for persons of all ages and, as the players acquire greater skill, considerable excitement will be created in playing the game.

Having thus described the invention, what is claimed as new is:

1. A game apparatus comprising a playing field of cushioning material, a disk representing a ball, disks of contrasting colors adapted to rest upon the playing field, flippers adapted to be manually engaged with any one of the disks to cause it to jump across the playing field, and goals at the ends of the playing fields to receive the disk representing a ball.

2. A game apparatus comprising a playing field of cushioning material, playing elements adapted to rest upon the field and having contrasting colors whereby one of said elements may represent a ball and the other elements represent opposing players, flippers to be pressed manually upon the edge portion of any one of said elements and cause movement of the same upon the playing field, and goals arranged at the ends of the playing field to receive the ball.

3. A game apparatus comprising a playing field of cushioning material, playing elements adapted to rest upon the field, one of said elements representing a ball, means for causing movement of the elements upon the field, and goals to receive the ball-representing element at the ends of the field comprising bases, standards removably engaged in the bases and overhanging the same, bumpers removably engaged upon the upper overhanging ends of the standards, baskets carried by said bumpers, and counterweights removably fitted upon the bases at the outer sides of the standards.

4. A game apparatus comprising a playing field of cushioning material, playing

elements adapted to rest upon the field, means for causing movement of said elements over the field, and goals disposed at the ends of the field and comprising standards having overhanging upper ends extending inwardly beyond the vertical plane of their lower ends whereby they may be brought into the vertical planes of the respectively adjacent ends of the playing field, and baskets carried by the upper ends of the standards. 10

In testimony whereof I affix my signature.

JAMES G. DAVIES. [L. s.]